

FläktGroup

AIRTREND Ltd
Predstavništvo u Beogradu
Kumanovska 14, 11000 Beograd
Tel: 011/3836886, 3085740
Faks: 011/3444113
e-mail: gobrid@eunet.rs
web: www.airtrend.rs

> AIR TREATMENT

DENCO-OfficeCool

DENCO[®] -OfficeCool

» UNDERFLOOR AIR CONDITIONING



26 °C

High level, high temperature return air back to the Zone Unit to complete the cycle

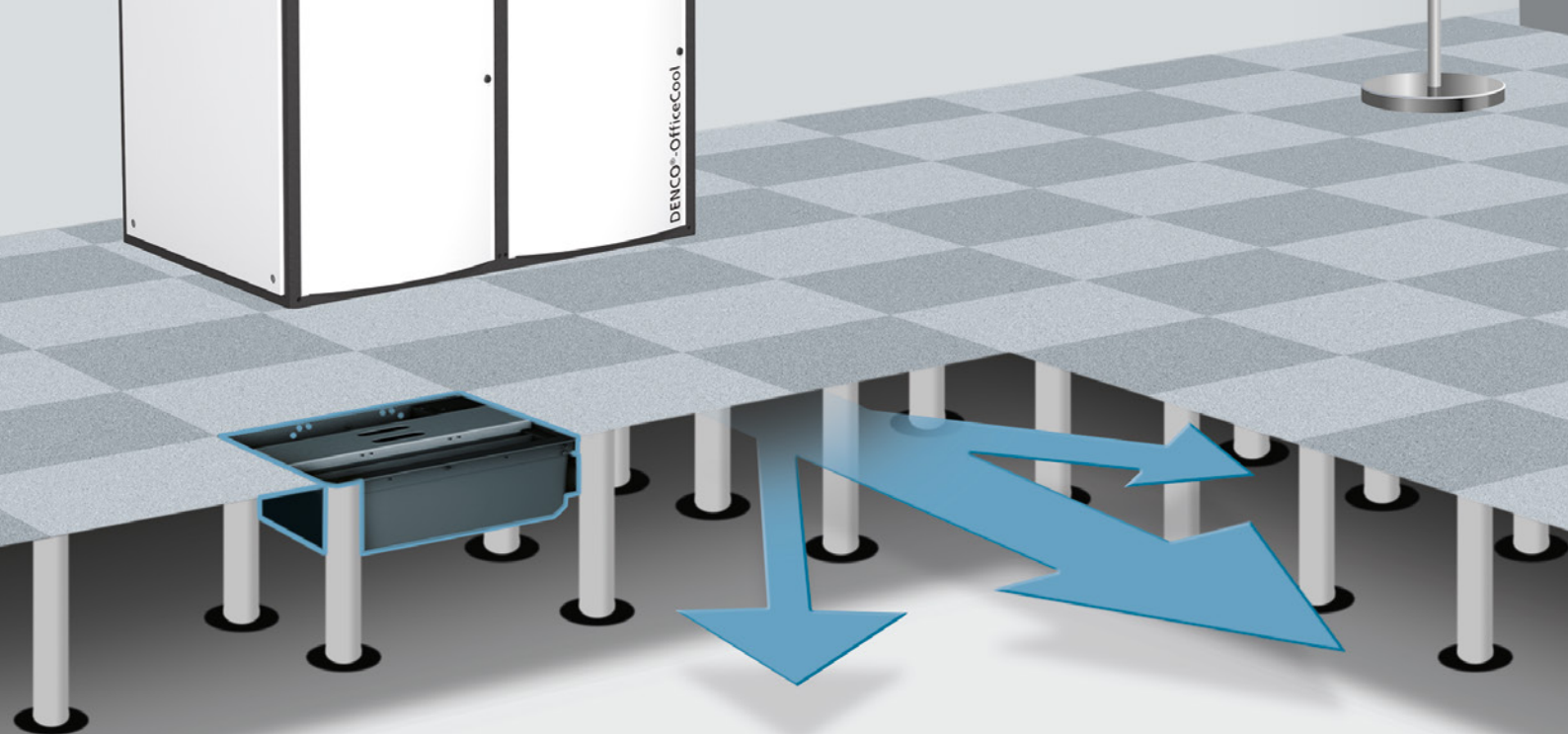

12-16 °C

Conditioned air under the floor

FläktGroup-POINTS

- No requirement for large plant rooms
- Individual control of local environment
- System redundancy
- Office space quickly and easily adapted for new occupants
- Construction savings
- Quiet operation
- Energy savings
- Installation can be deferred until final build/let
- Easy to design
- Quick easy office modifications possible
- Quick installation
- Reduced "slab to slab" height

24°C

Occupants control their own local environment depending on their needs

20°C

Mixed air supply from LECU to room at low velocity

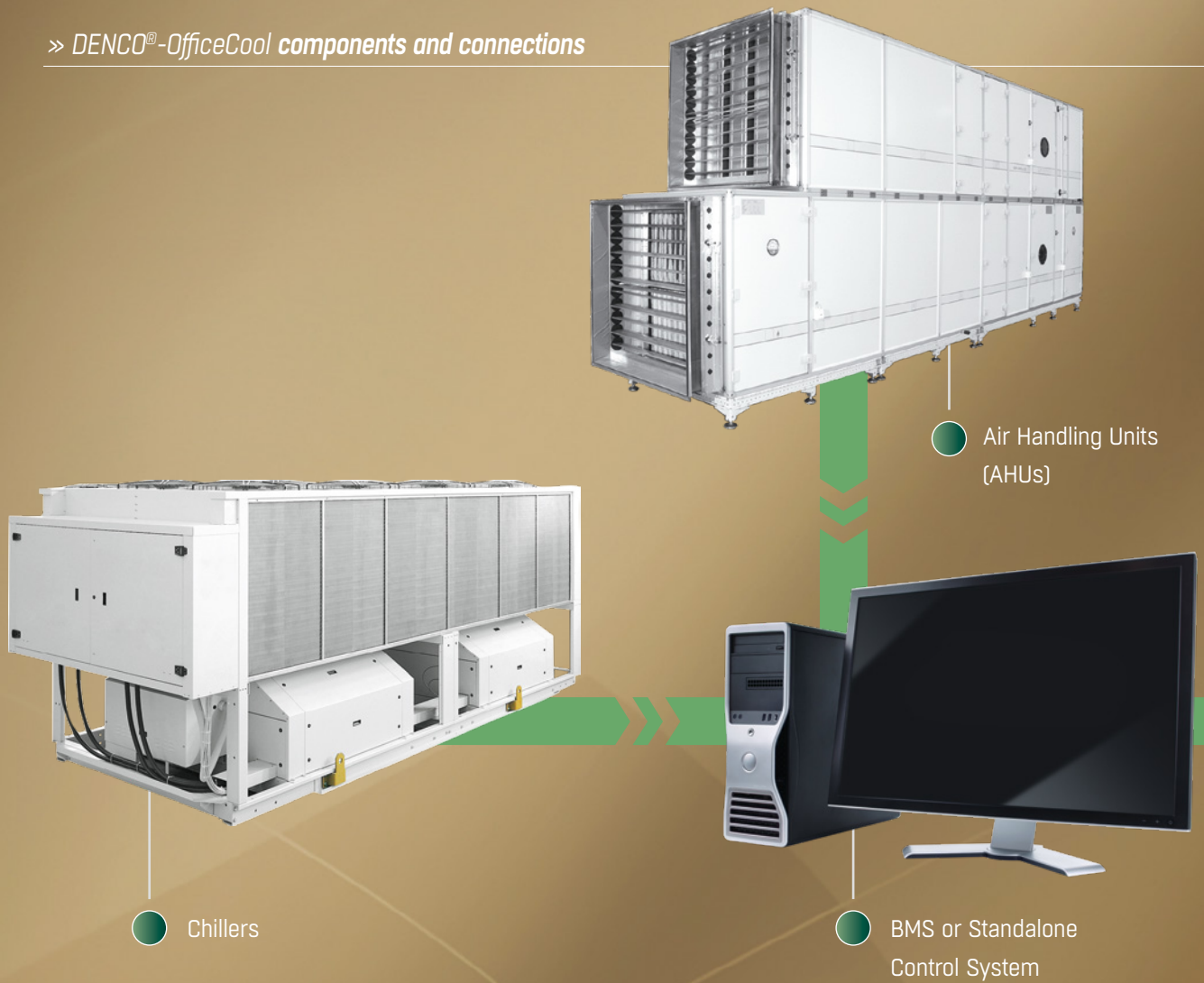

COMPLETE SYSTEM SOLUTIONS

Zone Unit

The Zone Unit provides the primary air conditioning to its zone, with each zone measuring up to 300 m². Zone Units are draw through vertical type, either top return (Downflow) or bottom return (Upflow) supplying conditioned air into a raised floor void. Zone Units have all necessary components such as filters, cooling coils, control valves, microprocessor controllers, and EC fans to achieve the required underfloor condition with the maximum efficiencies. Options include heating (electrical, low-pressure hot water, or direct expansion), dehumidification and humidification using water vapour. Zone Unit configuration can be either top return bottom discharge or bottom return bottom discharge, and are available in three standard sizes (from 7 kW – 30 kW). Other sizes are available on request.

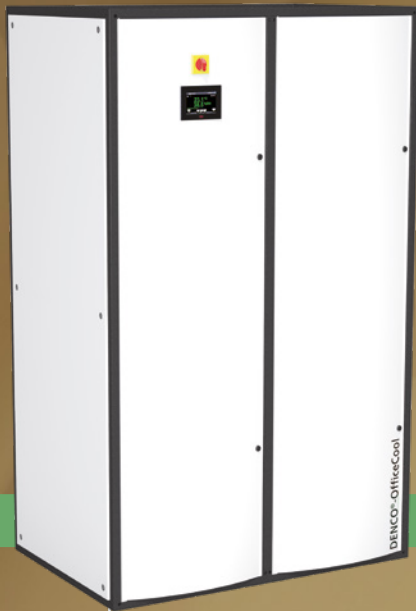

● Zone Unit

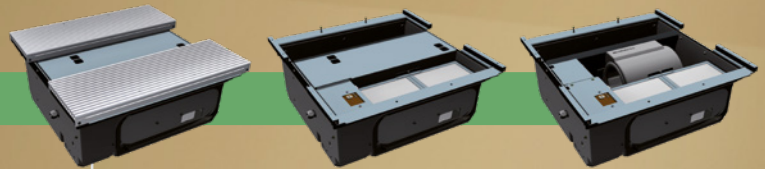

● LECUs

Local Environmental Control Unit (LECU)

Each Zone Unit is connected to up to 35 LECUs, which gives the DENCO-OfficeCool Air Conditioning System the exceptional ability to cope with changing office layout requirements. The LECU is an intelligent fan tile, easily positioned anywhere in the raised floor and provides the user with control over their "micro-climate". Each LECU includes a fan, a modulating damper and intelligent controller with the option of an electrical heater and will maintain the locally desired set temperature by re-circulating a varying mixture of air from the room and conditioned air from under the raised floor.

Air Handling Unit (AHU)

The AHU is sized to meet the fresh air requirements of the offices and delivers the fresh air to the return air side of the Zone Unit.

Chiller

The Chiller is sized to meet the cooling requirements of the entire building.

» The DENCO®-OfficeCool concept – **designed to users' specifications**

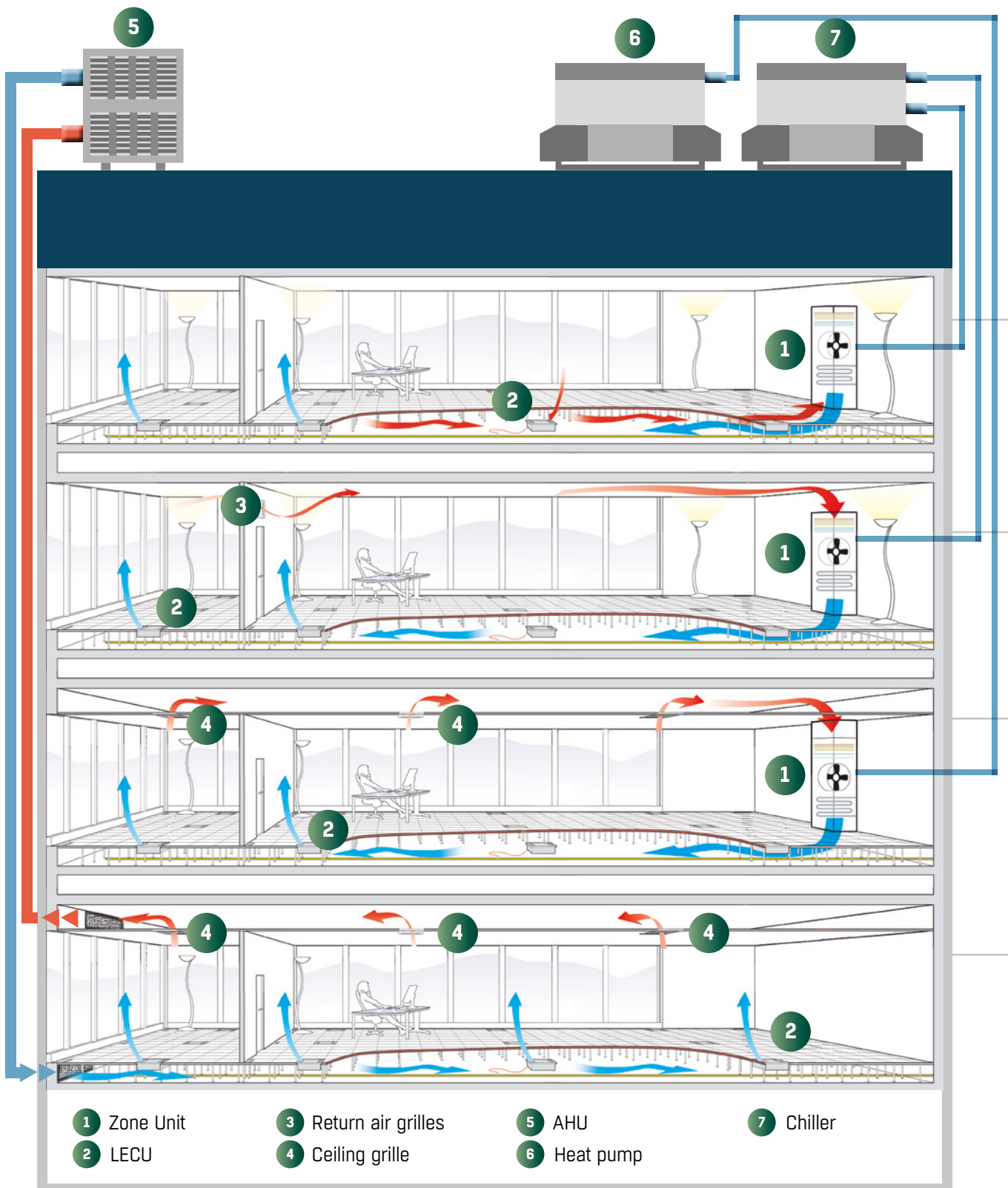

Configurations for every room size, **every requirement and condition**

External plant space

The heat rejection equipment, such as Chillers, Heat Pumps and Air Handling Units can all be installed externally.

Bottom air supply and return (Upflow type Zone Unit and LECU)

Where no ceiling is installed or where the integrity of the space above the raised floor is important, the Zone Unit supplies and returns the air within the access floor space. This space is simply divided into supply and return air plenums with underfloor barriers. Cooling and heating can be provided by chilled water and low pressure hot water or by heat pumps. The space is conditioned by the Zone Unit, and the LECUs provide the occupants with the ability to control their space.

Bottom air supply and high level return (Downflow type Zone Unit and LECU)

The Zone Unit supplies conditioned air into the access floor void and hot air is returned to the Zone Unit at high level. Cooling and heating can be provided by chilled water and low pressure hot water or by heat pumps. The space is conditioned by the Zone Unit, and the LECUs provide the occupants with the ability to control their space.

Bottom air supply and ceiling return (Downflow type Zone Unit and LECU)

The Zone Unit supplies conditioned air into the access floor void and hot air is returned to the Zone Unit through a suspended ceiling. Cooling and heating can be provided by chilled water and low pressure hot water or by heat pumps. The space is conditioned by the Zone Unit, and the LECUs provide the occupants with the ability to control their space.

Conditioning by external Air Handling Unit (AHU and LECU)

The air conditioning of the space can be done by an externally mounted Air Handling Unit, which supplies conditioned air through ducts into the access floor. The hot air is returned to the Air Handling Unit through the ceiling and duct system. The LECUs provide the occupants with the ability to control their space.



Benefits at a glance

- Almost cost free relocation capability
- Exceptionally quiet operation
- Local environment control for individuals
- Control of temperature and humidity for a healthier environment
- Filtration of both fresh air and re-circulated air for a healthier environment
- Economical operation
- Easy maintenance with all services at low level in the raised floor
- Elimination of draughts

COMPONENTS

ZONE UNIT AND LECU

CONTROLS



- Several controller options available
- Standard controller pCO5
- All units can be fitted, as an option, with a Trend interface
- Various interfaces for building management systems, etc.
- Monitoring display

SENSORS



- Water sensor (optional)
- Sensors for measuring air condition

FILTER

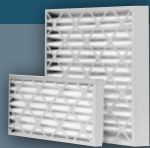

- High-quality EU4 Z-Line filter
- F7 filters, EU7 and washable filters are also available
- Differential pressure switch in the microprocessor control system indicates necessary filter change

STEAM HUMIDIFIER (OPTIONAL)



- Proportional control electrode steam humidifier
- Microprocessor control with alarm and diagnosis unit



Zone Unit

COOLING COILS

- CW or DX multi-row constructed
- Inclined, high performance coil with rippled aluminium fins, spaced at 1.8 mm.
- Aluminium intermediate drip tray with a stainless steel condensate drain tray with U trap
- 4 row and 6 row coils available



HEATING

- Low pressure hot water, with coils constructed of 3/8" OD copper tube, and mechanically bonded aluminium fins
- In heat pump installations, reverse cycle heat pump provides heating through the evaporator/condenser coil
- Electric Heating (optional), with stainless steel fins on heating elements and over temperature thermostatic safety cut out

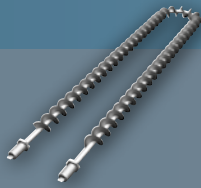

EC FANS

- Direct driven variable speed high efficiency EC plug fan with 7 backward curved three dimensional profiled blades
- Impeller optimally balanced according to ISO1940 and fan speed modulates on standard settings
- Variable speed regulation is performed using a 0-10 V controller signal



CHILLED WATER CONTROL VALVES

- Continuously modulated 2- or 3-way valves
- Provided with vapour sealed insulation



LECU AND COMPONENTS

Grilles

- Rectangular grilles

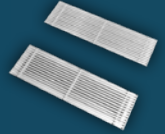

Fan section

- Single forward curved centrifugal fan
- Integrated single IP 44 closed type central electric motor
- Both AC and EC versions are available



Filter (optional)

- G2 filter in sheet metal frame



Electric heater

- 500 W electric heater



Control system and accessories

- Handheld IR Remote Controller with IR Receiver PCB
- LED display with ability to change air-flow or set point



Components

- PlantWatch Pro touch screen display
- PlantVisor for remote system monitoring

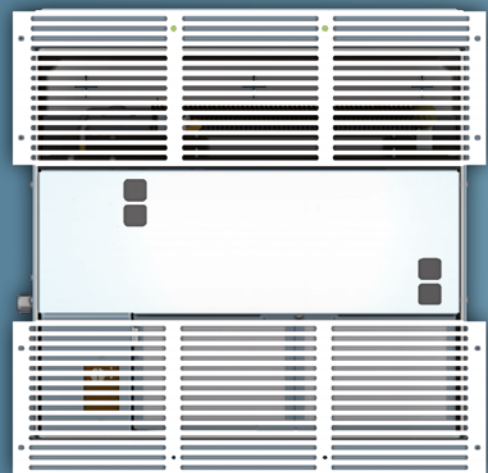

LECU

Technical data

Energy savings, carbon footprint and cost-efficiency

Indoor unit | H-Version Split System

		Size 010	Size 018	Size 030	Size 045
Selection¹					
Gross total capacity	kW	8.3	14.5	23.3	34.4
Gross sensible capacity	kW	6.6	11.4	18.7	27.6
Dehumidification capacity	kW	1.7	3.1	4.6	6.8
General					
Number of filters [Type]		2 [G4]	2 [G4]	2 [G4]	3 [G4]
EER efficiency ratio		4.29	4.27	4.28	2.44
Heat exchanger face area	m ²	0.33	0.58	0.95	1.42
Cooling		Direct Expansion Cooling			
Refrigerant type		R410A	R410A	R410A	R410A
Refrigerating circuits		1	1	1	1 or 2
Pressure equipment directive category		SEP	SEP	2	2
Fan²					
Number		1	1	1	1
Air volume flow	m ³ /h	1,496	2,574	4,320	6,361
Air volume flow	m ³ /s	0.42	0.72	1.20	1.77
External static pressure	Pa	50	50	50	50
Power consumption	kW	0.2	0.3	0.3	0.5
Humidifier (optional)		Electrode boiler			
Humidification capacity	kg/h	3	3	8	8
Power consumption	kW	2.3	2.3	6	6
Heater (optional)		via Modulating electric heating			
Heating capacity	kW	4	6	9	12
Current consumption	A	17.4	8.7	13.1	17.4
Heater		via Low pressure hot water (40°C / 60°C)			
Heating capacity	kW	6	11.1	18.2	26.5
Hot water volume flow	m ³ /h	0.26	0.49	0.8	1.16
Pressure drop heating	kPa	2	4	3	2
Electrical		400 V / 3ph / 50 or 60Hz			
Power consumption cooling mode	kW	2.1	3.7	5.9	15.4
Current consumption cooling mode	A	2.9	5	7.7	19.9
Current consumption max.	A	29	21	43	72
Connections					
Cooling - In Out	Inch	5/8" 5/8"	5/8" 3/8"	5/8" 7/8"	2 x 5/8" 2 x 7/8"
LPHW - In Out	mm	20 20	20 20	25 25	32 32
Humidifier water feed	mm	15	15	15	15
Water drain	mm	22	2x22	22	22

Outdoor unit | H-Version Split System

		Size 010	Size 018	Size 030	Size 045
Selection					
Number of outdoor units		1 outdoor unit	1 outdoor unit	1 outdoor unit	1 or 2 outdoor unit
Electric		400 V / 3ph / 50 or 60Hz			
Power consumption	kW	2	3.4	5.6	7.5
Current consumption	A	2.4	4.4	7	9.5
Current consumption max.	A	8	8	24	24
Connections					
Liquid line	Inch	3/8"	3/8"	3/8"	1/2"
Suction line	Inch	5/8"	5/8"	1"	1"

¹ Return air = 26°C / 50% R.H. Ambient Air = 35°C | ² Nominal Airflows

Indoor unit | O-Version Chilled Water System

		Size 010	Size 018	Size 030	Size 045
Selection¹					
Gross total capacity	kW	7.9	13.6	23	34.3
Gross sensible capacity	kW	6.4	11.1	18.6	27.6
Dehumidification capacity	kW	1.5	2.6	4.4	6.7
General					
Number of filters [Type]		2 [G4]	2 [G4]	2 [G4]	3 [G4]
EER efficiency ratio		48.95	44.66	64.37	63.96
Heat exchanger face area	m ²	0.33	0.58	0.95	1.42
Cooling					
			Chilled Water		
Cooling medium volume flow	m ³ /h	1.13	1.95	3.3	4.92
Unit pressure loss	kPa	18	18	19	14
Maximum operating pressure	bar	10	10	10	10
EC Plug Fan					
Number		1	1	1	1
Air volume flow	m ³ /h	1,496	2,574	4,320	6,361
Air volume flow	m ³ /s	0.42	0.72	1.20	1.77
External static pressure	Pa	50	50	50	50
Power consumption	kW	0.2	0.3	0.4	0.5
Humidifier (optional)					
			Electrode boiler		
Humidification capacity	kg/h	3	3	8	8
Power consumption	kW	2.3	2.3	6	6
Heater (optional)					
			via Modulating electric heating		
Heating capacity	kW	4	6	9	12
Current consumption	A	17.4	8.7	13.1	17.4
Heater					
			via Low pressure hot water (40°C / 60°C)		
Heating capacity	kW	6	11.1	18.2	26.5
Hot water volume flow	m ³ /h	0.26	0.49	0.8	1.16
Pressure drop heating	kPa	2	4	3	2
Electrical					
			400 V / 3ph / 50 or 60Hz		
Power consumption cooling mode	kW	0.2	0.3	0.4	0.5
Current consumption cooling mode	A	0.5	0.7	0.8	1
Current consumption max.	A	8	8	17	18
Connections					
Cooling - In Out	Inch	3/4 3/4	1 1	1-1/4 1-1/4	1-1/2 1-1/2
LPHW - In Out	mm	20 20	20 20	25 25	32 32
Humidifier water feed	mm	15	15	15	15
Water drain	mm	22	2x22	22	22

Design advice provided by local DENCO-OfficeCool specialist office. Specifications and unit schedules provided by local FläktGroup office for inclusion into design schedules. Life cycle cost analyses (LCCA) can be provided on request. Full selection carried out by local DENCO-OfficeCool specialist office. DX, heat pump and AHU selections provided on request.

Energy comparison DENCO-OfficeCool vs traditional FCU and AHU model

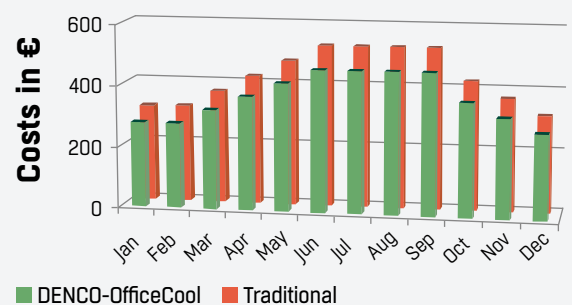

LECU operation and control

For flexible office concepts

Cooling mode

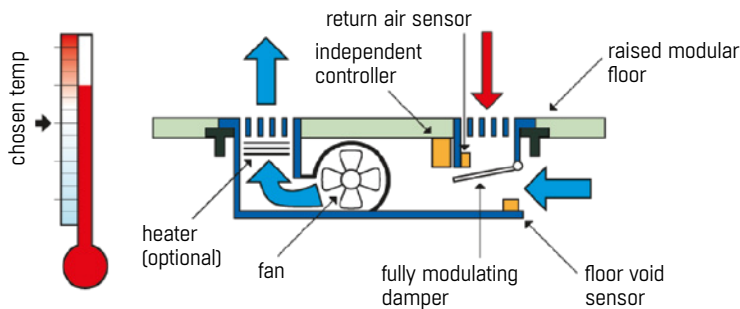

Cooling mode

If the room sensor detects that the local temperature is too warm, it interrogates the underfloor sensor. If the underfloor temperature is below that of the room air, the damper is modulated open to allow cooling to the space. The damper is modulated sufficiently to offset the heat gain to the space.

Heating mode

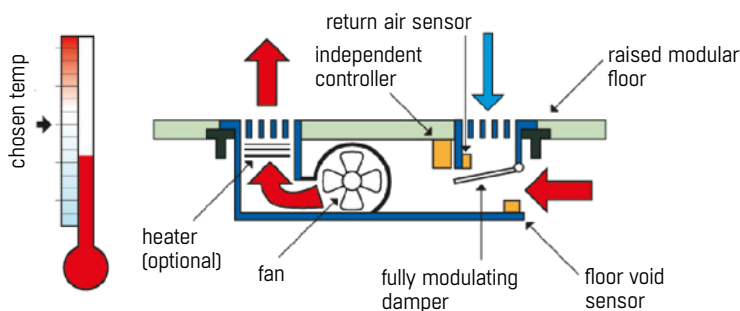

Heating mode

If the room sensor detects that the local temperature is too cold, it interrogates the underfloor sensor. If the underfloor temperature is above that of the room air, the damper is modulated open to allow heating to the space. The damper is modulated sufficiently to offset the heat loss to the space.

Recirculation mode

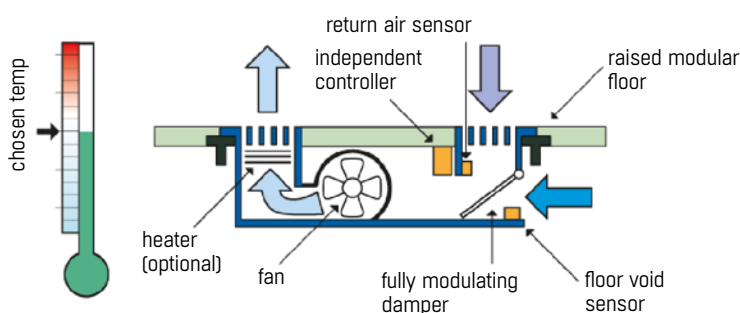

Recirculation mode

When the room sensor detects that the local temperature matches the set point, the damper will be closed and the unit will be in recirculation mode. An adjustable bleed damper allows sufficient air from the floor void to provide the fresh air requirements for the space.

Electric heater mode

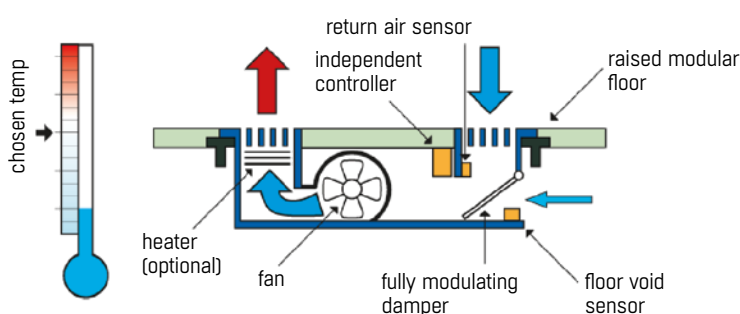

Electric heater mode (optional)

Under exceptional circumstances, if the room sensor detects that the local temperature is too cold and upon interrogation of the underfloor sensor it is determined that there is insufficient heat available, the controller will modulate the damper fully closed and initiate the electric heater battery. The heater will be on until such time that either the under floor temperature increases sufficiently to meet the heating requirement, or the room temperature increases to the set point.

Local Environment Control Unit (LECU)

The LECU gives the Denco-OfficeCool Air Conditioning System an exceptional ability to cope with the changing work space layout requirements. It is an intelligent fan tile, easily positioned anywhere in the floor of any work space. The LECU operates at 0-10 volt (although AC versions with 3 selectable fan speeds are available) and an adjustable set-point to meet users requirements. It maintains the locally desired set temperature by re-circulating a varying mixture of air from the room and conditioned underfloor air.

The LECU has its own frame and can be used with stringerless raised floors. It exactly matches a 600 x 600 raised floor panel and only weighs 18 Kg. Relocation of LECUs can be accomplished in minutes and enables the Denco-OfficeCool Air Conditioning System to adapt to your changing work space layout.

Adjustment of the LECU operation is available in different forms. At its simplest, adjustment of the set point and fan speed can be done directly via an infra red, hand-held remote control or the optional display mounted on the LECU.

The Building Management System (BMS) allows monitoring or adjustment of the set point and fan speed as well as monitoring of the entire system using selectable variables. When the LECU and the Zone Units are networked, the Zone Unit can be controlled by the average of the readings on the room sensors of the LECUs within any particular zone.

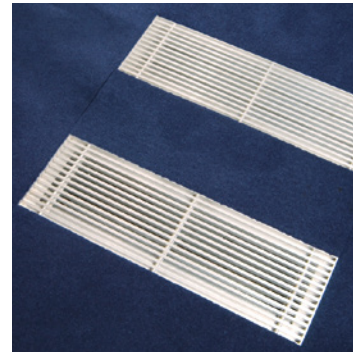

Under what conditions which configuration is used?

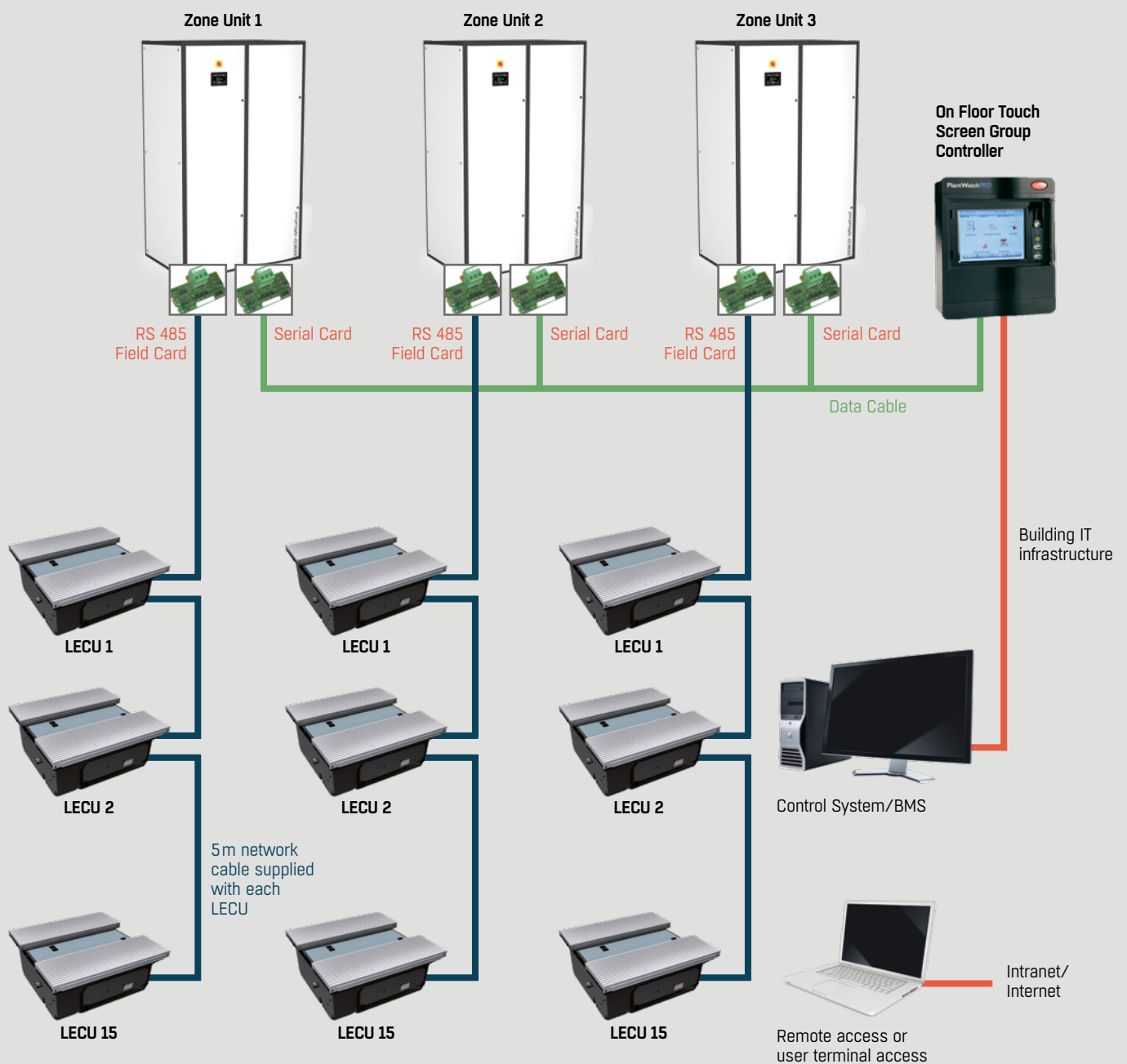

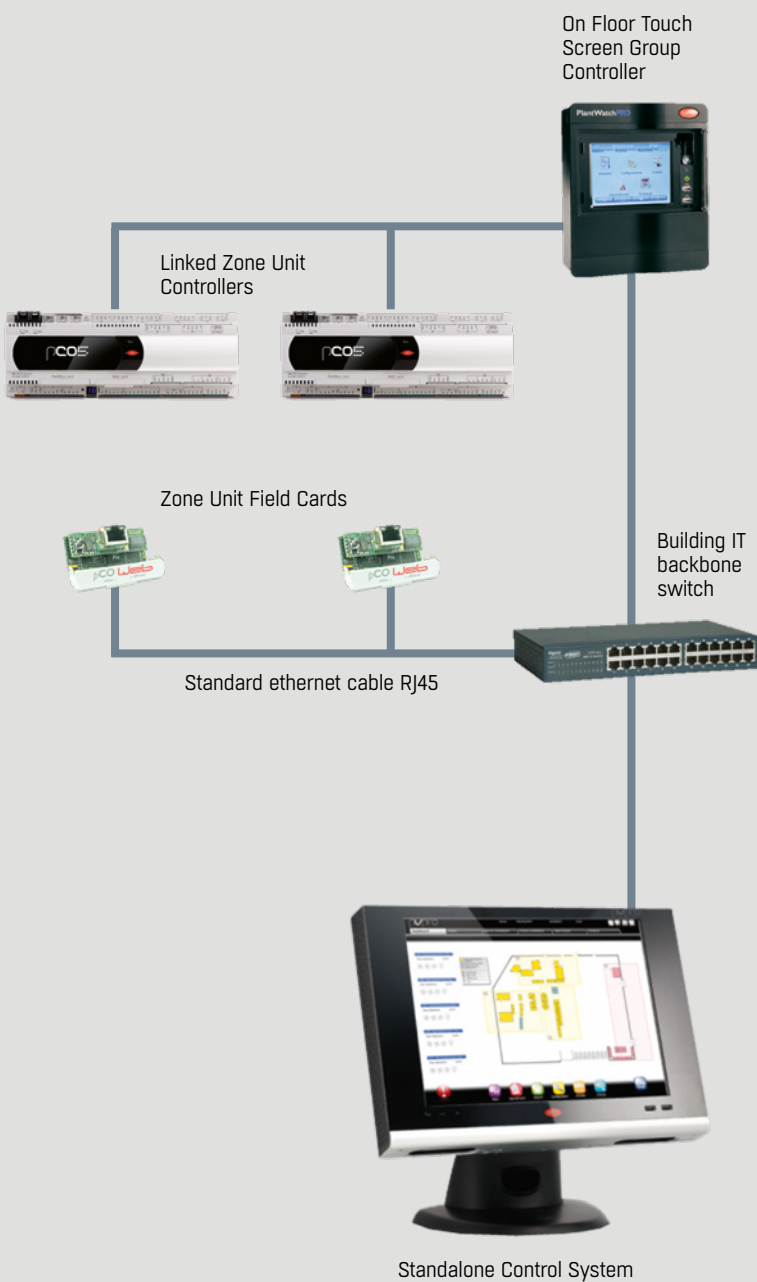

A fully linked control system provides communication between end users and individual LECUs. With integration possible between the building's own BMS and/or a purpose built control system just for Denco-OfficeCool.

FläktGroup's own purpose written software allows for seamless communication of all Denco-OfficeCool components, with data logging, alarm warnings as standard. User input is possible from many locations for ease of access, quick and easily adjustable temperature settings for maximum flexibility and comfort for all.

Other options for layout and operation

There are a number of additional features which allow the users to get the maximum benefit from the Denco-OfficeCool Air Conditioning System. An on floor touch screen group controller, or IQView 8, can be installed in the system. These provide a "mini-headend" capability for smaller installations that have no BMS, or where a BMS is installed, it provides tenants, or users, with the control over the equipment installed at floor plate level.

Dimensional drawings and technical data

Zone Unit

Zone Unit		Downflow version				Upflow version			
Model size		ZD 10	ZD 18	ZD 30	ZD 45	ZU 10	ZU 18	ZD 30	ZD 45
Weights and dimensions									
Weight	kg	110	180	270	340	125	195	285	355
Height (H)	mm	1,940	1,940	1,940	1,940	2,216	2,216	2,316	2,466
Width (W)	mm	600	800	1,180	1,670	904	1,304	1,684	2,374
Depth (D)	mm	600	600	780	780	600	600	780	780

Upflow air configuration (bottom supply, bottom return)

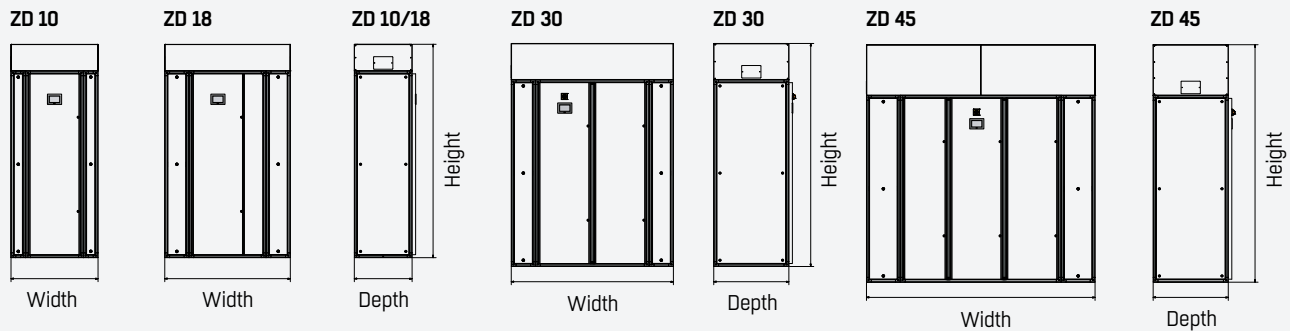

Downflow air configuration (bottom supply, top return)

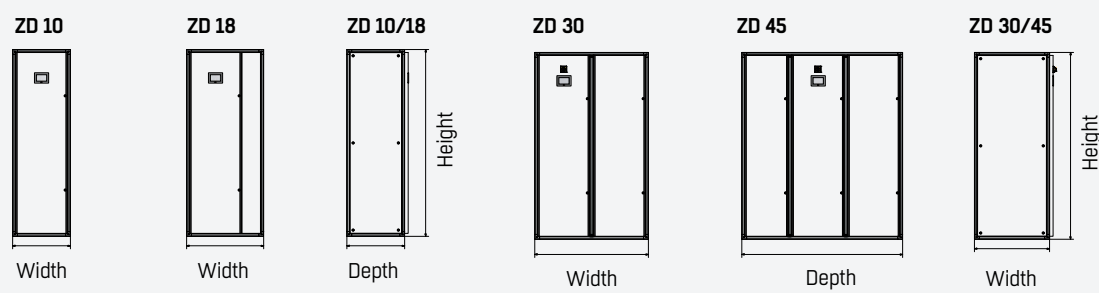

Dimensional drawings and technical data

Zone Unit

LECU

Weights and dimensions	
Weight	15 kg
Height (w/o grilles)	229 mm
Width frame	595 mm
Depth frame	595 mm
Width	489 mm
Depth	556 mm

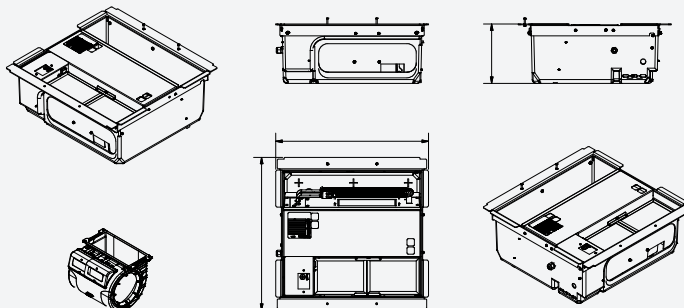

LECU 230 mm

EC Cooling mode, 0 Pa pressure					
Voltage V	Volume flow m³/h	Power consumption W	Current A	Noise pressure NR*	Noise power db(A)
3.3	250	9	0.07	16	38
5.4	330	16	0.12	25	47
7.4	420	25	0.19	32	54
9.4	480	35	0.27	36	57
10 (max.)	491	38	0.34	37	58

LECU 230 mm

AC Cooling mode, 0 Pa pressure					
Step	Volume flow m³/h	Power consumption W	Current A	Noise pressure NR*	Noise power db(A)
1	315	54	0.24	23	45
2	400	56	0.25	30	52
3 (max.)	500	57	0.25	37	58
Optional:	Electrical heater	500W heating power	2.2		

Rule of Thumb

Zone Unit size	Cooling capacity ca. kW	Area m²	Amount of LECUs	
10	5	50	3	To calculate approximate number of Zone Units: No. of Zone Units = total load/approx. capacity To calculate approximate number of LECUs: Number of LECUs = supply airflow/0.11 To double check the number of LECUs: Number of LECU = floor plate area/15 m²
18	10	100	5	
30	20	200	10	
45	30	300	15	

*in 3 m distance



YOUR BENEFIT

DENCO-OfficeCool is a very modular solution with systematic sophistication, which promises the following: made-to-measure and space-saving climate control with maximum reliability and energy-efficiency.

Certificates

- Quality Assurance – EN ISO 9001:2008
- CE marking for all EU relevant products
- Safety of Machinery: EN 60204-1:2006+A1:2009
- Safety of Machinery: N ISO 12100-1:2003
- Safety of Machinery: EN ISO 12100-2:2003
- EMC Emissions: EN 61000-6-3:2007
- EMC Immunity: EN 61000-6-2:2005
- Refrigeration Systems: EN 378-1/2/3/4:2008
- ASME 9

ALWAYS FOCUSING ON THE CUSTOMER

Quality management from development to after-sales

We, the FläktGroup experts for climate and environment solutions, are the European market leaders for the entire spectrum of air treatment. Quality is one of our key success factors. Looking back on more than 100 years of experience we have continuously improved and optimized our products and business operations, keeping one central goal in focus: Exceeding our customers' expectations.



Production facility in Wuhu, China



Factory in Wurzen, Germany



Looking inside the FläktGroup site at Hereford, UK



Aerial photograph showing the factory in Liberec, Czech Republic



Production facility in Pune, India



The Turkey location in Istanbul

Air treatment competence around the globe

Over the past 100 years the FläktGroup experts for room climate solutions have established an international network of manufacturing sites. Centers of excellence for air handling units, close control units, decentral air treatment, and clean rooms are located in several countries throughout Europe and Asia. All of them deal constantly with the continuous improvement in production processes and optimization according to the latest international standards. With a clear focus on standardization, all sites can assure a high level of production flexibility. Furthermore, just in time production with short delivery times helps fulfil customer requirements. With integrated research and development facilities, we are able to handle even the most technically demanding projects. One of our special skills is advanced knowledge in metal sheet processing. No matter what our customers ask of us – reliability is the most decisive feature that characterizes all FläktGroup sites.



- Global approach
- International quality standards
- Constant improvement
- Flexible standardization
- Just in time production
- Customer in focus

SOLUTIONS FOR EVERY CLIMATIC DEMAND



MEPC Limited

MEPC manages some of the UK's best known commercial property, with seven Business Estates set in prime locations throughout the UK. Together they provide over 7 million sq ft of high quality space for more than 1,000 organizations, employing over 20,000 people. MEPC chose the DENCO-OfficeCool underfloor air conditioning system for over 10,000 sq m office accommodation, across 6 new buildings. In total, FläktGroup installed 70 Zone Units and 850 Local Environmental Control Units (LECU). MEPC desired the flexibility offered by DENCO-OfficeCool system, due to the relatively high fit-out alteration requirements of their tenants. The system also met MEPC's corporate sustainability objectives. FläktGroup has worked closely with MEPC to deliver the energy efficient solution, through chilled water cooling and DX heat pumps systems, which will achieve Class B Energy Performance Certification.

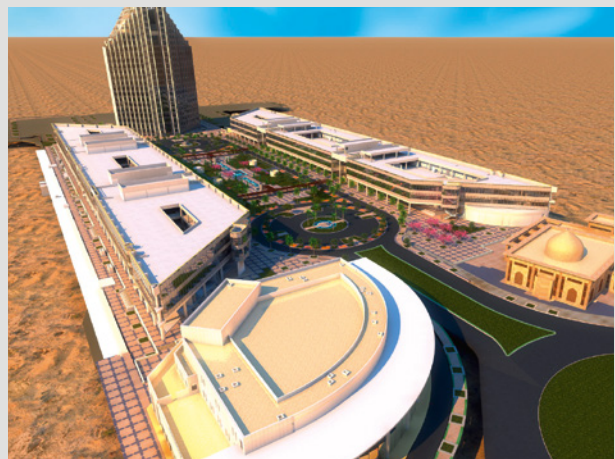

Public Authority for Applied Education and Training (PAAET) – AESS Building, Kuwait

PAAET selected the DENCO-OfficeCool underfloor air conditioning system for its new education campus in the Shuwaikh district of Kuwait. FläktGroup Middle East FZE supplied 416 x Zone type Air Handling Units and 5,000 x LECUs for the central tower and administrative wings of this building. All of the equipment supplied for this project was manufactured at our FläktGroup Liberec factory in the Czech Republic. This system is independently controlled via FläktGroup's own central control system which is fully integrated into the PAAET building management system.



YONHAP Media Center – Korea

This national television company has chosen a complete Denco-OfficeCool solution for their air conditioning requirements for their new state of the art studios in the centre of Seoul. The system was supplied by FläktGroup Middle East FZE and encompasses 24 x Air Handling Units all of which were manufactured in our FläktGroup Wurzen Plant in Germany, additionally there are 48 x Denco Ultra Zone Units and 1,500 LECUs which were manufactured in our Liberec plant in the Czech Republic.



AgustaWestland Helicopters

When AgustaWestland refurbished one of their office blocks they selected the Denco-OfficeCool underfloor air conditioning system. The office was air conditioned by 14 Zone Units and a number of Local Environmental Control Units (LECU), which allows employees control over their workspace temperature. When AgustaWestland install any new air conditioning system, they carefully review the energy efficiency of the system. The Denco-OfficeCool System with each Zone Unit is connected to a reverse cycle heat pump which provides a very energy efficient cooling and heating system. The fresh air for the system is provided by two Air Handling Units, with heat recovery, which provide additional energy savings.

First Service Always at your side



Our services at a glance

- Own heat exchanger production
- Use of certified products and components
- Use of components from well-known component manufacturers
- Short delivery times for spare parts
- Commissioning of new facilities
- Periodic servicing
- Maintenance
- Factory trial run
- Upgrading and optimisation of old facilities
- Maintenance agreements

- Initial installation
- Maintenance and servicing
- Assembly services
- Spare parts
- Customer service
- Consulting
- Refurbishing
- Training





Economical from the beginning

The technical developments of FläktGroup represent state-of-the-art swimming pool climate control. Our systems support diverse applications that optimally conform to current criteria of cost effectiveness, safety and sustainability. Our products and services go far beyond pure technology. They are integrated into a comprehensive and in every respect customised service package. This programme includes not only conventional services such as spare part delivery, maintenance, and repair. It unites the consulting and engineering of a technology leader with customised after-sales service and rapid response times. And this not only for installing new equipment. This service also applies for upgrading and optimising old equipment and provides you with perfect support in all project phases. The functionality of the system is secured over its entire service life.

International service and support in experienced hands

Wherever you need us, we will be there for you in the shortest time. All over Europe, our own customer service ensures that you are able to make optimal use of our units' advantages at all times. Many technicians are ready on-call in Germany alone for rapid deployment. All services are designed for absolute safety and reliability. For example, an on-site function check is a part of our delivery service, conducted by an experienced FläktGroup technician together with the installer. This way we directly and personally pass on our functional know-how built up over many years. In this context we should also mention the training we offer in the technology of our climate control systems. Such training is a beneficial instrument for ensuring the lasting functionality and availability of the systems.

A decision for quality

A high quality standard is the basis and principle for all our services. All our service specialists are highly experienced and devote themselves to their work with great diligence. Technically and personally convincing: this is what you can expect from us.

EXCELLENCE IN SOLUTIONS

WWW.FLAKTGROUP.COM

DENCO-OfficeCool

FläktGroup is the European market leader for smart and energy efficient Indoor Air and Critical Air solutions to support every application area. We offer our customers innovative technologies, high quality and outstanding performance supported by more than a century of accumulated industry experience. The widest product range in the market, and strong market presence in 65 countries worldwide, guarantee that we are always by your side, ready to deliver Excellence in Solutions.

PRODUCT FUNCTIONS BY FLÄKTGROUP

Air Treatment | Air Movement | Air Diffusion | Air Distribution
Air Filtration | Air Management | Air Conditioning & Heating
Controls | Service

» Learn more on www.flaktgroup.com
or contact one of our offices